

These are oil-free rotary vane vacuum pumps, with a suction flow rate of 4 m³/h.

Characterized by a cover and flange with a graphite disc. The use of special graphite vanes reduces maintenance interventions and ensures clean air at the pump outlet.

To minimize the overall dimensions, the pump's rotor is assembled to the motor shaft.

The BVS and BVL series pumps are supplied with single-phase or three-phase electric motors.

The motor and pump are cooled by the motor fan.

On the pump discharge, a filter with silencing function is installed.

The BVS and RMS series pumps can also be used as compressors.



Use and installation

The use of these pumps is not recommended when the fluid to be aspirated contains vapors, water or oil condensates.

For the installation of OMMER vacuum pumps, it is sufficient to connect them to the vacuum circuit and set up the electrical connection to the motor.

Please ensure the correct rotation direction of the pump.

004S			
Frequency		50Hz	60Hz
Flow rate	m ³ /h	4	4,8
Ultimate pressure	mbar	140	
Motor performance	3~	230/400±5%	265/460±5%
Volt	1~	230±5%	
Motor power	3~	0,18	0,22
kW	1~	0,18	
Motor protection	IP	55	
Rotation speed	rpm	2750	3300
Motor shape		Custom	
Motor size		63	
Weight	kg	6	

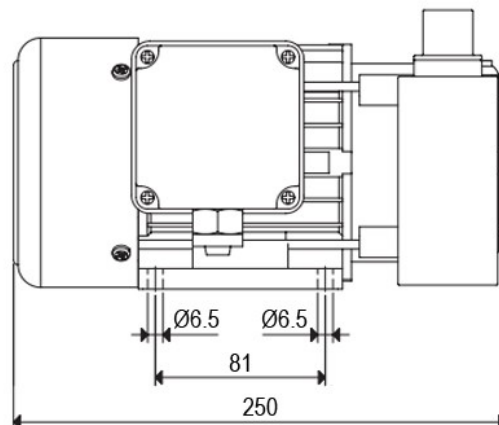
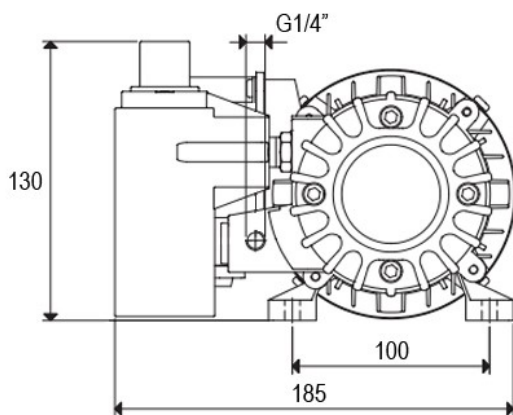

Data and dimensions are not mandatory. O.M.M.E.R. S.r.l. reserves the right to make changes and improvements at any time and without notice.

